



Ports and Pinouts





Cable Connectors

The pin numbers shown are for the connectors attached to the ends of the Macintosh peripheral cables, as viewed from the front of the connector.

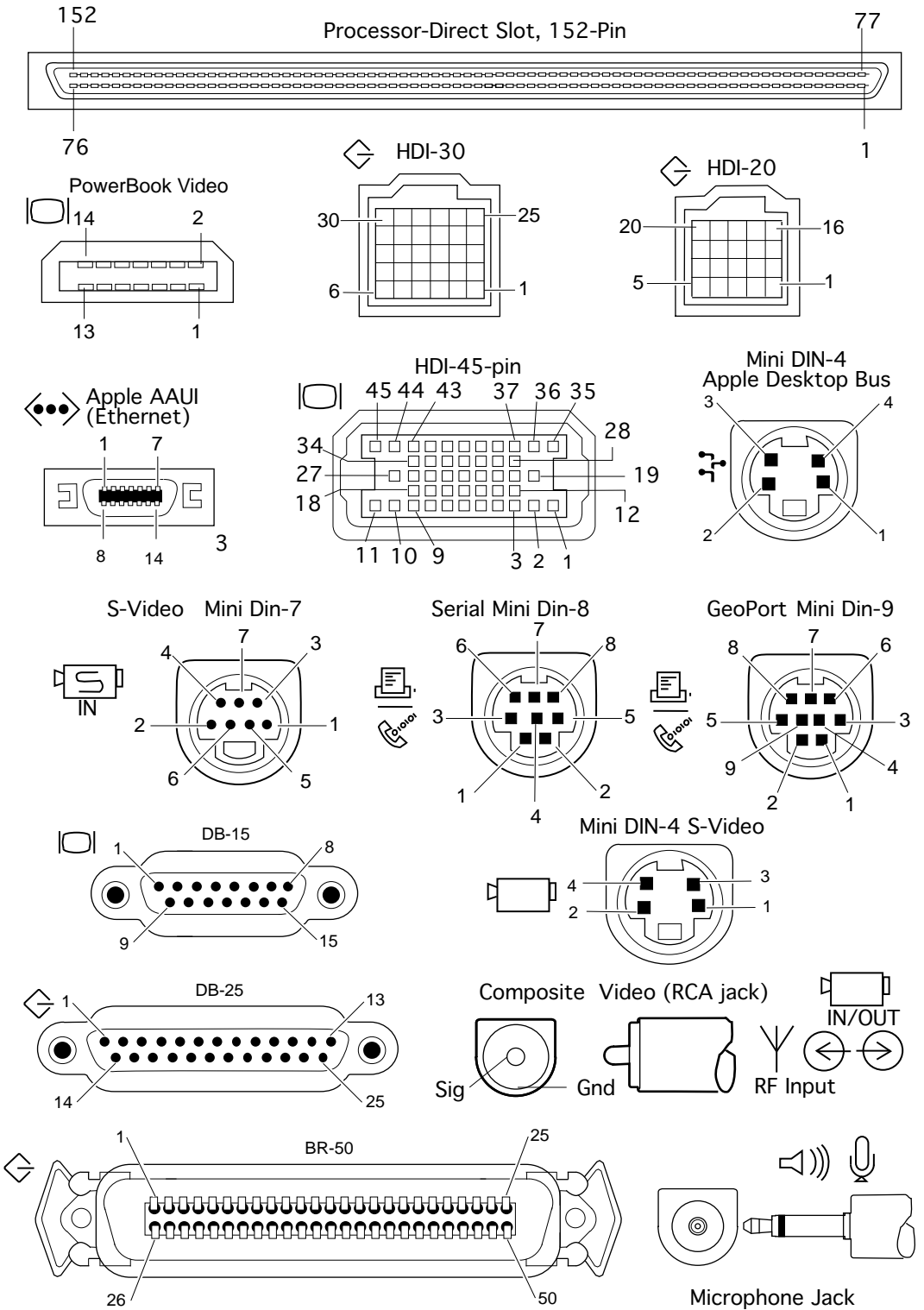



GeoPort Mini DIN-9

The back panel of all Power Macintosh models contain two I/O ports for serial telecommunication data. Both sockets accept 9-pin plugs, allowing either port to be independently programmed for asynchronous or synchronous communication formats up to 9600 bps. This includes AppleTalk and the full range of Apple GeoPort protocols.

Pin	Name	Function
1	SCLK (out)	Reset pod or get pod attention
2	Sync (in)/SCLK (in)	Serial clock from pod (up to 920 Kbit/sec.)
3	TxD-	Transmit -
4	Gnd/shield	Ground
5	RxD-	Receive -
6	TxD+	Transmit +
7	Wake up/TxHS	Wake up CPU or do DMA handshake
8	RxD+	Receive +
9	+5V	Power to pod (350 mA maximum)





Apple Desktop Bus (ADB) Connector

Connector type: Mini DIN-4 male.

The total length of all cables should not exceed 16 feet (5 meters).

Pin	Signal Name	Signal Description
1	Data	Bidirectional data bus
2 ^a	Power On/	Signal momentarily grounded to pin 4 to begin startup sequence in CPU
3	Power	+5 volts
4	Ground	Signal ground

a. On the Macintosh II family, Quadra 700 and 900, and PowerBook series only.
Pin 2 is unused on all other models.





Mouse Connector

Connector type: DE-9.

This connector is present on the Macintosh 128K, 512K, 512K enhanced, and Macintosh Plus.

Pin	Signal Name	Signal Description
1	GND	Signal ground
2	+5V	+5 volts DC
3	GND	Signal ground
4	X2	Left-to-right motion indicator
5	X1	Interrupt line (left-to-right motion)
6	NC	No connection
7	SW	Mouse button
8	Y2	Up-down motion indicator
9	Y1	Interrupt line (up-down motion)





Keyboard Connector

Connector type: RJ-11.

This connector is present on the Macintosh 128K, 512K, 512K enhanced, and Macintosh Plus.

Pin	Signal Name	Signal Description
1	GND	Ground
2	CLOCK	Keyboard clock (input to VIA)
3	DATA	Serial data line
4	+5V	+5 volts





Modem and Printer Ports

Connector type: DE-9.

This connector is present on Macintosh 128K, 512K, and 512K enhanced.

Upper set of signal names and descriptions applies to RS-422. Lower set applies to RS-232.

Pin	Signal Name	Signal Description
1	GND FG	Signal ground Frame ground
2	+5V NC	+5 volts No connection
3	GND SG	Signal ground Signal ground
4	TXD+ NC	Transmit Data + No connection
5	TXD- TXD	Transmit Data - Transmit Data
6	+12V NC	+12 volts No connection
7 ^a	HSKi NC	Handshake input No connection
8 ^b	RXD+ NC	Receive Data + No connection
9	RXD- RXD	Receive Data - Receive Data

a. When connecting to an RS-232 device, use HSKi with data set ready (DSR) or other handshaking signals, depending on the device to be connected.

b. When connecting to an RS-232 device, connect pin 8 to pin 3 (ground).





Connector type: Mini-DIN 8.

This connector is not present on Macintosh 128K, 512K, and 512K enhanced computers.

To connect DE-9 cables to the Mini DIN-8 port, use adapter cable 590-0341 (beige) or 590-0553/699-0430 (smoke)..

Pin	Signal Name	Signal Description
1	HSKo	Handshake out
2	HSKi	Handshake in/external clock
3	TxD-	Transmit data -
4	GND	Signal ground
5	RxD-	Receive data -
6	TxD+	Transmit data +
7 ^a	NC	General-purpose input
8	RxD+	Receive data +

a. On serial port A (modem), if the VIA1 SYNC signal is high, this input will be routed to the receive/transmit clock input of the SCC. This clock input supports high-speed synchronous devices. Pin 7 is not connected on the Macintosh Plus, LC, or IIsi.





RCA Jack Pinout

Pin	Input Connector	Output Connector
1	AGND	AGND
2	AGND	AGND
3	Video Y (luminance)	Video Y (luminance)
4	Video C (chroma)	Video C (chroma)
5	I ² C clock (I-squared) ^a	Composite Video
6	+12V at 250 mA maximum ^b	No connection
7	I ² C data ^a	No connection

a. Phillips serial bus

b. Fused at 1.1A





HDI-45

Connector type: 45-pin high-density interconnect (HDI-45).

The Power Macintosh computers provide connection to AudioVision monitors (and other monitors when used with an adapter cable) by means of an AudioVision HDI-45 monitor socket on their back panels.

Pin	Description	Pin	Description
1	Analog audio ground	24	Reserved
2	Audio input shield	25	Reserved
3	Left channel audio input	26	Red ground (shield)
4	Right channel audio input	27	Red video output (75 ohms)
5	Left channel audio output	28	I ² C data signal ^a (I-squared)
6	Right channel audio output	29	I ² C clock signal ^a (I-squared)
7	Reserved	30	Reserved
8	Monitor ID sense line 1	31	Monitor ID
9	Monitor ID sense line 2	32	Monitor ID
10	Green ground (shield)	33	Vertical sync signal
11	Green video output (75 ohms)	34	Composite sync signal
12	Video input power ground	35	ADB power +5V
13	Power for camera +5V	36	ADB ground
14	Reserved	37	ADB data
15	Reserved	38	Keyboard switch
16	Reserved	39	Reserved
17	Reserved	40	Reserved
18	Monitor ID sense line 3	41	Monitor ID
19	S-video input shield	42	Horizontal sync signal
20	S-video input luminance (Y)	43	Video sync ground
21	S-video input chroma (C)	44	Blue ground (shield)
22	Reserved	45	Blue video output (75 ohms)
23	Reserved		

a. Phillips serial bus interface.





Ethernet: AAUI Connector Pinouts

The Apple Attachment Unit Interface (AAUI) connector is a 14-position, 0.050-inch-spaced ribbon contact connector. AAUI signals have the same description, function, and electrical requirements as the AUI signals of the same name, as detailed in the IEEE Standard 802.3-1990 CSMA/CD, section 7.

Pin	Signal Name	Signal Description
1	FN Pwr	Power (+12V @ 2.1W or +5V @ 1.9W)
2	DI-A	Data in circuit A
3	DI-B	Data in circuit B
4	VCC	Voltage Common
5	CI-A	Control in circuit A
6	CI-B	Control in circuit B
7	+5V	+5 volts (from host)
8	+5V	Secondary +5 volts (from host)
9	DO-A	Data Out circuit A
10	DO-B	Data Out circuit B
11	VCC	Secondary Voltage Common
12	NC	Reserved
13	NC	Reserved
14	FN Pwr	Secondary +12V @ 2.1W or +5V @ 1.9W
Shell	Protective Gnd	Protective Ground





Audio Output Connector: Stereo

Connector type: Stereo miniature phone plug (3.6 mm).

The internal speaker is disabled when this connector is in use.

Pin	Signal Name	Signal Description
(Sleeve)	GND	Signal ground
(Tip)	Left	1-volt ^a , peak-to-peak audio signal with an impedance of 47 ohms, left channel
(Ring)	Right	1-volt ^a , peak-to-peak audio signal with an impedance of 47 ohms, right channel

a. The PowerBook series produce a 0.75-volt, peak-to-peak signal.





Audio Output Connector: Monaural

Connector type: Monaural miniature phone plug (3.6 mm).
The internal speaker is disabled when this connector is in use.

Pin	Signal Name	Signal Description
(Sleeve)	GND	Signal ground
(Tip)	AUDIO	.5-volt, peak-to-peak audio signal





Microphone Input Connector

Connector type: Stereo miniature phone plug (3.6 mm).

Caution: Do not connect any device other than the Macintosh microphone into the microphone input connector. The connector provides +8 volts for the microphone. Connecting incompatible devices could damage the device or computer.

Pin	Signal Name	Signal Description
(Sleeve)	GND	Signal ground
(Tip)	+8V	+8 volts for powering electret microphone
(Ring)	Right	Audio input with a maximum amplitude of 20 mV at 600 ohms impedance





Line Input Connectors

Connector type: RCA phono plug.

This connector is present on the Macintosh Quadra 900/950. Two connectors are provided—right and left channel. The stereo information will be internally mixed to yield a monaural signal.

Pin	Signal Description
(Sleeve)	Digital ground
(Tip)	Audio input





HDI-30 and BR-50 SCSI Disk Adapter Cable

These connectors are found on the SCSI Disk Adapter cable. The pin numbers not mentioned are reserved.

HDI-30	BR-50	Signal Name	Signal Description
2	26	/DB0	SCSI data bit 0
1,3	19	GND	Ground, Pin 1 enables SCSI disk mode
4	27	/DB1	SCSI data bit 1
5	38	TERMPWR	Termination Power (not supplied by PowerBook 100)
6	28	/DB2	SCSI data bit 2
7	29	/DB3	SCSI data bit 3
8	1,4	GND	Ground
9	44	/ACK	SCSI acknowledge
10	5	GND	Ground
11	30	/DB4	SCSI data bit 4
12	2,3,8	GND	Ground
13	11,9,6	GND	Ground
14	31	/DB5	SCSI data bit 5
15	24	GND	Ground
16	32	/DB6	SCSI data bit 6
17	7	GND	Ground
18	33	/DB7	SCSI data bit 7
19	34	/DBP	SCSI data bit parity
20	23, 16, 20	GND	Ground
21	49	/REQ	SCSI request
22	21, 22	GND	Ground
23	43	/BSY	SCSI busy
24	25	GND	Ground
25	41	/ATN	SCSI attention
26	48	/C/D	SCSI control/data
27	45	/RST	SCSI bus reset





HDI-30	BR-50	Signal Name	Signal Description
28	46	/MSG	SCSI message
29	47	/SEL	SCSI select
30	50	/I/O	SCSI input/output





External Video Connector: 15-Pin

Connector type: DA-15 male.

This connector is present on the Macintosh LC, LC II/ Performa 400, Ilici, Ilsi, Quadra 700, Quadra 900/950, Macintosh Duo Dock, and Duo MiniDock.

Pin	Signal Name	Signal Description
1	RED.GND	Red video ground
2	RED.VID	Red video
3	CSYNC/	Composite sync
4	MON.ID1	Monitor ID, bit 1
5	GRN.VID	Green video
6	GRN.GND	Green video ground
7	MON.ID2	Monitor ID, bit 2
8	NC	No connection
9	BLU.VID	Blue video
10	MON.ID3	Monitor ID, bit 3
11	C&VSYNC GND	Composite & vertical sync ground
12	VSYNC/	Vertical sync
13	BLU.GND	Blue video ground
14	HSYNC.GND	Horizontal sync ground
15	HSYNC/	Horizontal sync
Shell	CHASSIS GND	Chassis ground





External Video Connector: Macintosh Portable

Connector type: 15-pin, high-density, D-shaped male.

Pin	Signal Name	Signal Description
1	FPDATA(0)	Flat-panel display data bus (bit 0)
2	FPDATA(1)	Flat-panel display data bus (bit 1)
3	+5V	+5 volts DC
4	FPDATA (2)	Flat-panel display data bus (bit 2)
5	FPDATA(3)	Flat-panel display data bus (bit 3)
6	FPDATA(4)	Flat-panel display data bus (bit 4)
7	GND	Ground
8	+5V	+5 volts DC
9	GND	Ground
10	FPDATA(5)	Flat-panel display data bus (bit 5)
11	FPDATA(6)	Flat-panel display data bus (bit 6)
12	FPDATA(7)	Flat-panel display data bus (bit 7)
13	BATTVOLTAGE	Direct connect to main battery
14	FLM	Flat-panel new frame sync
15	CL2/	Flat-panel display data clock





External Video Connector: 14-Pin

Connector type: 14-pin, high-density female.

All Apple-manufactured Macintosh monitors except the 21-inch Color Display and Two-Page Monochrome Monitor are supported.

Pin	Signal Name	Signal Description
1	RED.VID	Red video
2	RED.GND	Red video ground
3	MON.ID1	Monitor ID, bit 1
4	VSYNC/	Vertical sync
5	CSYNC/	Composite sync
6	C&VSYNC.GND	Composite and vertical sync ground
7	GRN.GND	Green video ground
8	GRN.VID	Green video
9	MON.ID2	Monitor ID, bit 2
10	HSYNC.GND	Horizontal sync ground
11	MON.ID3	Monitor ID, bit 3
12	HSYNC/	Horizontal sync
13	BLU.VID	Blue video
14	BLU GND	Blue video ground
Shell	CHASSIS GND	Chassis ground





SCSI Connector: DB-25

Total length of all SCSI cables should not exceed 20 feet (6 meters).

Caution: This interface uses the same type of connector as a standard RS-232 serial interface but is electrically very different. Do **not** connect RS-232 devices or cables to this port. Doing so can damage the device and the computer.

Pin	Signal Name	Signal Description	Pin	Signal Name	Signal Description
1	REQ/	Request	14	GND	Signal ground
2	MSG/	Message	15	C/D/	Control/data
3	I/O/	input/output	16	GND	Signal ground
4	RST/	Reset	17	ATN/	Attention
5	ACK/	Acknowledge	18	GND	Signal ground
6	BUSY/	Busy	19	SEL/	Select
7	GROUND	Signal ground	20	PARITY/	Data parity
8	Data0/	Data bit 0	21	Data1/	Data bit 1
9	GND	Signal ground	22	Data2/	Data bit 2
10	Data3/	Data bit 3	23	Data4/	Data bit 4
11	Data5/	Data bit 5	24	GND	Signal ground
12	Data6/	Data bit 6	25	TERMPWR	+5 volts terminator power
13	Data7/	Data bit 7			





SCSI Connector: HDI-30

Connector type: 30-pin high-density interconnect (HDI-30).

This connector is present on the Macintosh PowerBook series (except the Duo 210/230).

Pin	Signal Name	Description	Pin	Signal Name	Description
1	SCSI-Mode/	SCSI disk mode enable signal	16	Data6/	Data bit 6
2	Data0/	Data bit 0	17	GND	Signal ground
3	GND	Signal ground	18	Data7/	Data bit 7
4	Data1/	Data bit 1	19	PARITY/	Data parity
5	Termpwr	+5 volts termination power	20	GND	Signal ground
6	Data2/	Data bit 2	21	REQ/	Request
7	Data3/	Data bit 3	22	GND	Signal ground
8	GND	Signal ground	23	BUSY/	Busy
9	ACK/	Acknowledge	24	GND	Signal ground
10	GND	Signal ground	25	ATN/	Attention
11	Data4/	Data bit 4	26	C/D/	Control/data
12	GND	Signal ground	27	RST/	Reset
13	GND	Signal ground	28	MSG/	Message
14	Data5/	Data bit 5	29	SEL/	Select
15	GND	Signal ground	30	I/O/	Input/output





External Floppy Drive Connector: DB-19

Connector type: DB-19 male.

This connector is present on the Macintosh 128K, 512K, 512K enhanced, Plus, SE, SE/30, Classic, Classic II/Performa 200, Portable, IICX, IICI, IISI, and IIvi/IIvx/Performa 600.

A Macintosh 400K External Drive can be connected to the Macintosh 128K, 512K, 512K enhanced, Plus, SE, and Portable.

A Macintosh 800K External Drive or an Apple 3.5 Drive can be connected to the Macintosh 512K enhanced, Plus, SE, SE/30, Classic, Classic II/Performa 200, IICX, IICI, IISI, Portable, and IIvi/IIvx/Performa 600.





Connect an Apple SuperDrive to a Macintosh SE (FDHD upgrade), SE/30, Classic, Classic II, IICx, IICi, IISI, Portable, and IIVI/IIVX/Performa 600.

Connect a Hand Disk 20 to a Macintosh 512K, 512K enhanced, Plus, and SE.

Pin	Signal Name	Signal Description
1	GND	Signal ground
2	GND	Signal ground
3	GND	Signal ground
4	GND	Signal ground
5	-12V	-12 volts DC
6	+5V	-5 volts DC
7	+12V	+12 volts DC
8	+12V	+12 volts DC
9	NC	No connection
10	PWM	Motor speed control
11	PH0	Command control line
12	PH1	Command control line
13	PH2	Command control line
14	PH3	Command control line
15	WRREQ/	Write request
16	HDSEL	Head select
17	ENBL2/	Read line enable
18	RD	Read data
19	WR	Write data





External Floppy Drive Connector: HDI-20

Connector type: 20-pin high-density interconnect (HDI-20).

This connector is present on the Macintosh Duo MiniDock and PowerBook Duo Floppy adapter. An HDI-20 1.4 MB drive can be connected to this port.

Pin	Signal Name	Description
1	GND	Signal ground
2	GND	Signal ground
3	GND	Signal ground
4	GND	Signal ground
5	NC	No connection
6	+5V	+5 volts DC
7	+5V	+5 volts DC
8	+5V	+5 volts DC
9	+5V	+5 volts DC
10	NC	No connection
11	PH0	Phase 0
12	PH1	Phase 1
13	PH2	Phase 2
14	PH3	Phase 3
15	WREQ/	Write request
16	HDSEL	Head select
17	ENBL2/	External drive select
18	RD	Read data
19	WR	Write data
20	NC	No connection





External Monitor Connector

Connector type: DB-15.

Pin	Description
1	Red ground
2	Red video signal
3	Composite synchronization
4	Monitor sense 0
5	Green video signal
6	Green ground
7	Monitor sense 1
8	No connection
9	Blue video signal
10	Monitor sense 2
11	Synchronization ground
12	Vertical synchronization
13	Blue ground
14	Horizontal synchronization
15	Horizontal synchronization ground





S-Video Input

The Power Macintosh AV card also contains two identical connectors for S-video input and output, with adapter cables for composite video devices that have RCA connectors (like television equipment).

Pin	Input Connector	Output Connector
1	AGND	AGND
2	AGND	AGND
3	Video Y (luminance)	Video Y (luminance)
4	Video C (chroma)	Video C (chroma)
5	I ² C clock (I-squared) ^a	Composite video
6	+12V at 250 mA maximum ^b	No connection
7	I ² C data ^a	No Connection

a. Phillips serial bus

b. Fused at 1.1 A





Macintosh II Display Cards

Connector type: DA-15 male.

Caution: The signals on this connector are not the same as on the DA-15 of the Apple IIc, IIGS, III, III Plus, or EtherTalk Interface Card. Do **not** connect an Apple IIc, IIGS, III, III Plus, or EtherTalk Interface Card device or cable to any Macintosh video card.

The interface cards covered in this table include the Macintosh II High-Resolution Video Card, Macintosh II Extended High-Resolution Video Card, and Macintosh Display Cards 4•8, 8•24, and 8•24GC.

Pin	Signal Name	Signal Description
1	RED.GND	Red video ground
2	RED.VID	Red video
3	CSYNC/	Composite sync
4	MON.ID1	Monitor ID, bit 1
5	GRN.VID	Green video
6	GRN.GND	Green video ground
7	MON.ID2	Monitor ID, bit 2
8	NC	No connection
9	BLU.VID	Blue video
10	MON.ID3	Monitor ID, bit 3
11	C&VSYNC GND	Composite & vertical sync ground
12	VSYNC/	Vertical sync
13	BLU.GND	Blue video ground
14	HSYNC.GND	Horizontal sync ground
15	HSYNC/	Horizontal sync
Shell	CHASSIS GND	Chassis ground





The interface cards covered in this table include the Macintosh II Video Card (4- and 8-bit) and Monochrome Video Card (1-bit).

Caution: The signals on this connector are not the same as on the DA-15 of the Apple IIc, IIGS, III, III Plus, or EtherTalk Interface Card. Do **not** connect an Apple IIc, IIGS, III, III Plus, or EtherTalk Interface Card device or cable to any Macintosh video card.

Pin	Signal Description
1	Red signal ground
2	Analog red video
3	Composite sync
4	Sync signal ground
5	Analog green video
6	Green signal ground
7	No connection
8	No connection
9	Analog blue video
10	No connection
11	No connection
12	No connection
13	Blue signal ground
14	No connection
15	No connection
(Shield)	Shield ground





This table covers the second version of the Macintosh II Portrait Video Card.

Caution: The signals on this connector are not the same as on the DA-15 of the Apple IIc, IIgs, III, III Plus, or EtherTalk Interface Card. Do **not** connect an Apple IIc, IIgs, III, III Plus, or EtherTalk Interface Card device or cable to any Macintosh video card.

Pin	Signal Name	Signal Description
1	RED.GND	Red video ground
2	RED.VID	Red video
3	CSYNC/	Composite sync
4	MON.ID1	Monitor ID, bit 1
5	GRN.VID	Green video
6	GRN.GND	Green video ground
7	MON.ID2	Monitor ID, bit 2
8	NC	No connection
9	BLU.VID	Blue video
10	MON.ID3	Monitor ID, bit 3
11	C&VSYNC GND	Composite & vertical sync ground
12	VSYNC/	Vertical sync
13	BLU.GND	Blue video ground
14	HSYNC.GND	Horizontal sync ground
15	HSYNC/	Horizontal sync
Shell	CHASSIS GND	Chassis ground





Connector type: 13-pin, mixed-contact, D-type (Dartech FM-13W3S male or equivalent).

The interface cards covered in this table include Macintosh II Portrait Video Card (older version) and Macintosh II Two-Page Monochrome Video Card.

Pin	Signal Description
A1	Monochrome video
A2	No connection
A3	No connection
1	Horizontal sync return
2	Vertical sync
3	Sense #3
4	Sense ground
5	Composite sync
6	Horizontal sync
7	Vertical sync return
8	Sense #2
9	Sense #1
10	Composite sync return
Shell	Shell ground





EtherTalk Cards

Connector type: DA-15 male.

This connector supports thick coaxial cable with the use of an optional transceiver (not available from Apple).

Caution: The signals on this connector are not the same as on the DA-15 of the Apple IIc, IIGS, III, III Plus, or Macintosh II video cards. Do **not** connect an Apple IIc, IIGS, III, III Plus, or Macintosh II video card device or cable to the EtherTalk Interface Card.

The interface cards covered in this table include The EtherTalk Interface Card and EtherTalk NB Card.

Pin	Signal Description
1	Shield
2	Collision presence +
3	Transmit +
4	Reserved
5	Receive +
6	Power return
7	Reserved
8	Reserved
9	Collision presence -
10	Transmit -
11	Reserved
12	Receive -
13	Power
14	Reserved
15	Reserved





TokenTalk Cards

Connector type: DE-9 male.

The interface cards covered in this table include Apple TokenTalk NB Interface Card and Apple Token Ring 4/16 NB Card.

Pin	Signal Description
1	Receive data
2	No connection
3	No connection
4	No connection
5	Transmit data
6	Receive data
7	No connection
8	No connection
9	Transmit data





Coax/Twinax Interface Card: Coax Connector

Connector type: BNC male

Pin	Signal Name	Signal Description
(Tip)	CX+	Transmit/receive data
(Sleeve)	CX-	Signal ground





Coax/Twinax Interface Card: Twinax Connector

Connector type: DE-9 female.

Pin	Signal Description
1	No connection
2	No connection
3	No connection
4	No connection
5	No connection
6	No connection
7	“A” twinax signal
8	No connection
9	No connection
10	No connection
11	No connection
12	No connection
13	No connection
14	“B” twinax signal
15	No connection





Apple Serial NB Card

Connector type: DB-62 male.

Pin	Signal Name	Signal Description
1	+CA1F	X.21 control, +CHA1, output
2	232TXDA1	Transmit data, CHA1, RS-232, output
3	-CA1F	X.21 control, -CHA1, output
4	1RTSA	Ready To Send, CHA1, RS-232, output
5	1CTSA	Clear To Send, CHA1, RS-232, input
6	+CB1F	X.21 control, +CHB1, output
7	232TXDB1	Transmit data, CHB1, RS-232, output
8	-CB1F	X.21 control, -CHB1, output
9	1RTSB	Ready To Send, CHB1, RS-232, output
10	1CTSB	Clear To Send, CHB1, RS-232, input
11	+1B1	X.21 indication, +CHB1, input
12	232TXDA2	Transmit data, CHA2, RS-232, output
13	2RXDA	Receive data, CHA2, RS-232, input
14	2RTSA	Ready To Send, CHA2, RS-232, output
15	2CTSA	Clear To Send, CHA2, RS-232, input
16	+IA1	X.21 indication, +CHA1, input
17	232TXDB2	Transmit data, CHB2, RS-232, output
18	2RXDB	Receive data, CHB2, RS-232, input
19	2RTSB	Ready To Send, CHB2, RS-232, output
20	2CTSB	Clear To Send, CHB2, RS-232, input
21	+422TXCA1	+Transmit clock, CHA1, RS-422, input
22	-422TXCA1	-Transmit clock, CHA1, RS-422, input
23	+422RXDA1	+Receive data, CHA1, RS-422, input
24	-422RXDA1	-Receive data, CHA1, RS-422, input
25	+422RXCA1	+Receive clock, CHA1, RS-422, input
26	-422RXCA1	-Receive clock, CHA1, RS-422, input
27	+422TXDA1	+Transmit data, CHA1, RS-422, output
28	-422TXDA1	-Transmit data, CHA1, RS-422, output





Pin	Signal Name	Signal Description
29	+422TXCB1	+Transmit clock, CHB1, RS-422, input
30	-422TXCB1	-Transmit clock, CHB1, RS-422, input
31	+422RXDB1	+Receive data, CHB1, RS-422, input
32	-422RXDB1	-Receive data, CHB1, RS-422, input
33	+422RXC1	+Receive clock, CHB1, RS-422, input
34	-422RXC1	-Receive clock, CHB1, RS-422, input
35	+422TXDB1	+Transmit data, CHB1, RS-422, output
36	-422TXDB1	-Transmit data, CHB1, RS-422, output
37	GND_6	Extra ground
38	2TXCA	Transmit clock, CHA2, RS-232, input
39	2RXCA	Receive clock, CHA2, RS-232, input
40	2RXC1	Receive clock, CHB2, RS-232, input
41	GND_5	Extra ground
42	2TXC1	Transmit clock, CHB2, RS-232, input
43	1DSRA	Data Set Ready, CHA1, RS-232, input
44	1DCDA/-IA1	Data Carrier Detect, RS-232/X.21 indication, -CHA1, input
45	1DTRA	Data Terminal Ready, CHA1, RS-232, output
46	1RIA	Ring Indicator, CHA1, RS-232, input
47	GND_4	CHB2 ground
48	1DSRB	Data Set Ready, CHB1, RS-232, input
49	1DCDB/-IB1	Data Carrier Detect, RS-232/X.21 indication, -CHB1, input
50	1DTRB	Data Terminal Ready, CHB1, RS-232, output
51	1RIB	Ring Indicator, CHB1, RS-232, input
52	GND_3	CHA2 ground
53	2DSRA	Data Set Ready, CHA2, RS-232, input
54	2DCDA	Data Carrier Detect, CHA2, RS-232, input
55	2DTRA	Data Terminal Ready, CHA2, RS-232, output
56	2RIA	Ring Indicator, CHA2, RS-232, input
57	GND_2	CHB1 ground





Pin	Signal Name	Signal Description
58	2DSRB	Data Set Ready, CHB2, RS-232, input
59	2DCDB	Data Carrier Detect, CHB2, RS-232, input
60	2DTRB	Data Terminal Ready, CHB2, RS-232, output
61	2RIB	Ring Indicator, CHB2, RS-232, input
62	GND_1	CHA1 ground





10BaseT Connector (RJ-45 Connector)

Contact	Signal
1	TD+
2	TD-
3	RD+
4	Not Used by 10BaseT
5	Not Used by 10BaseT
6	RD-
7	Not Used by 10BaseT
8	Not Used by 10BaseT





Computer Port Locations

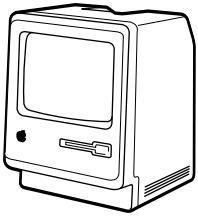

Macintosh 128K, 512K, 512K enhanced

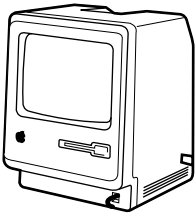
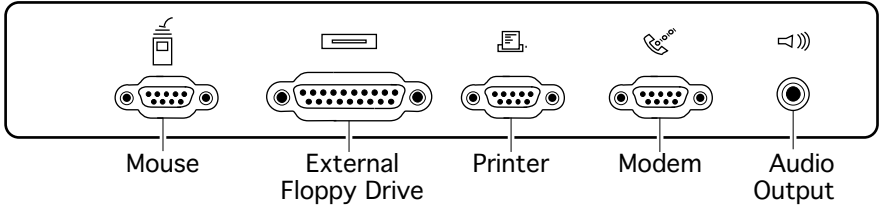

Macintosh Plus

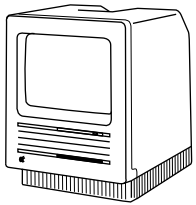
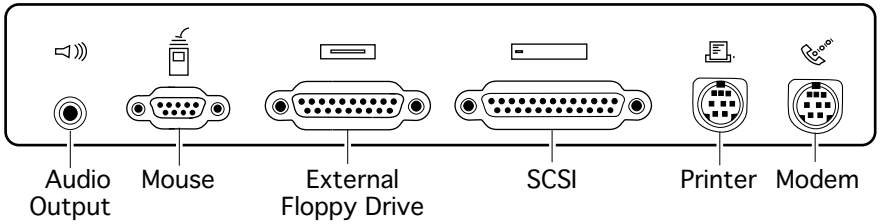

Macintosh SE & SE/30

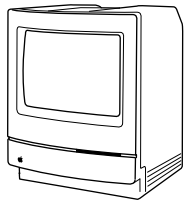
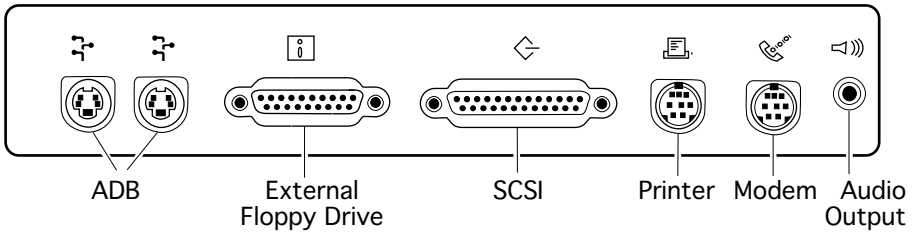

Macintosh Classic

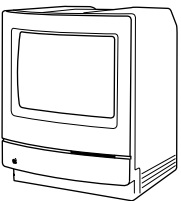
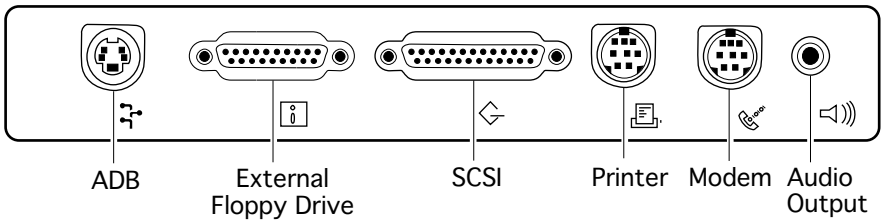

Macintosh Classic II / Performa 200

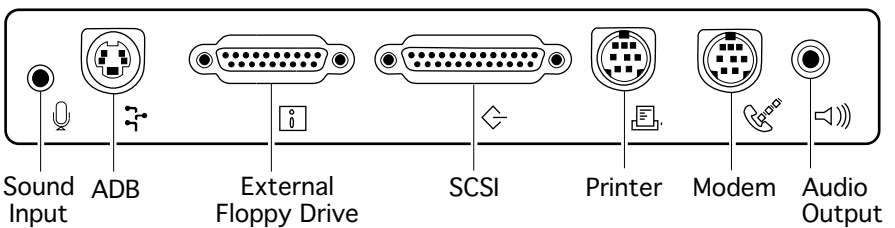

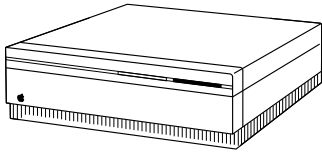

Macintosh II, IIx, IIcx

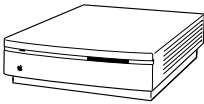
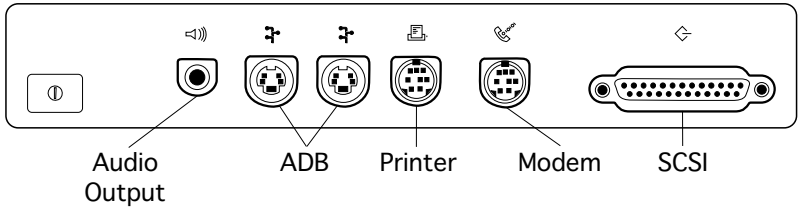

Macintosh IIsi

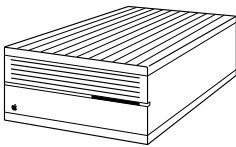
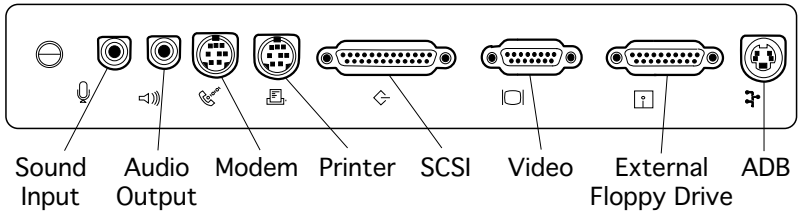

Macintosh IIcx

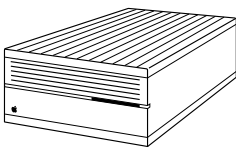
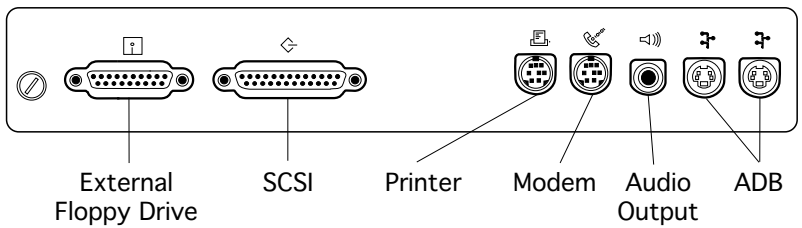

Macintosh IIci

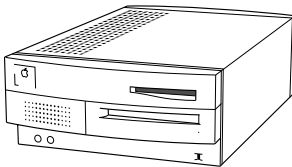
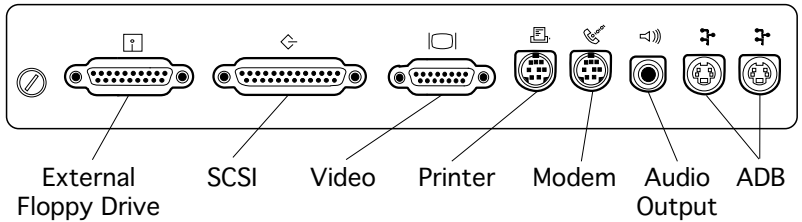

Macintosh IIvi, IIvx, Performa 600

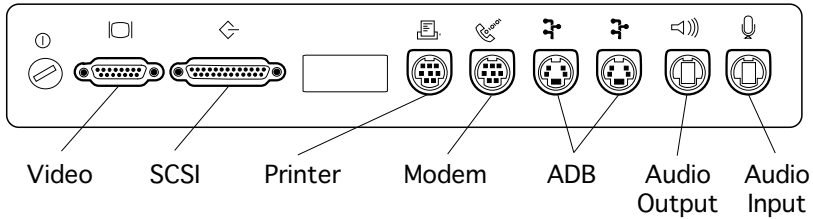



Macintosh Color Classic

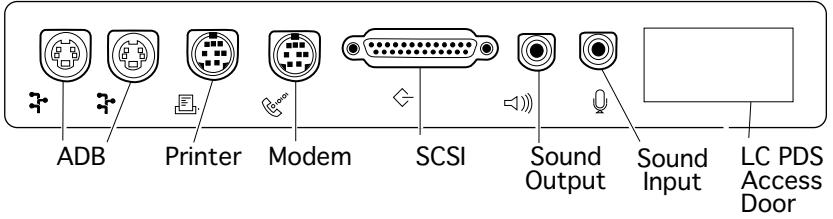
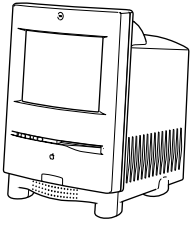

Macintosh LC 520, 550; Performa 550, 560

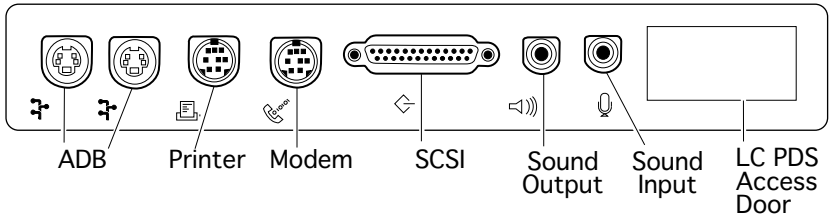
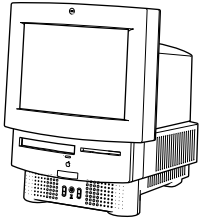

Macintosh LC 575; Performa 575

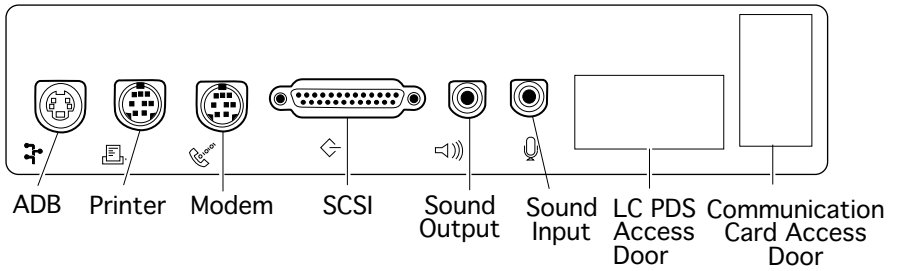
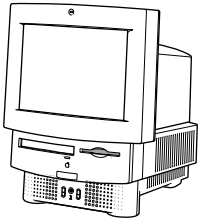

Macintosh TV

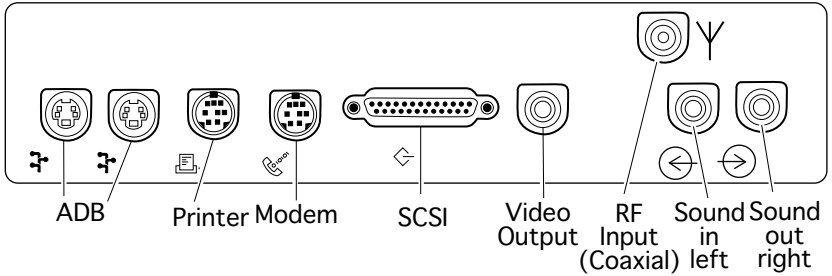
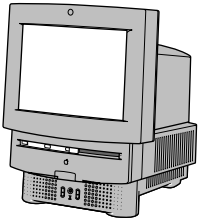

Macintosh LC III, LC 475; Performa 450, 460, 466, 467, 475, 476; Quadra 605

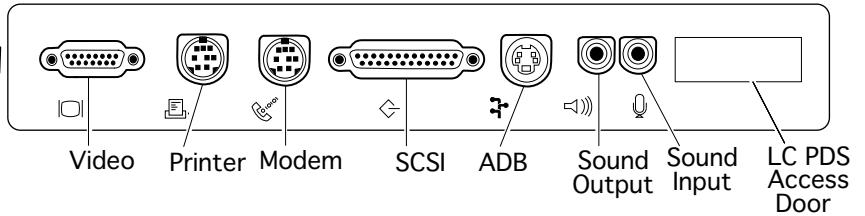
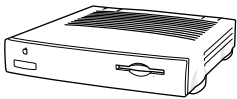



Macintosh Quadra 700

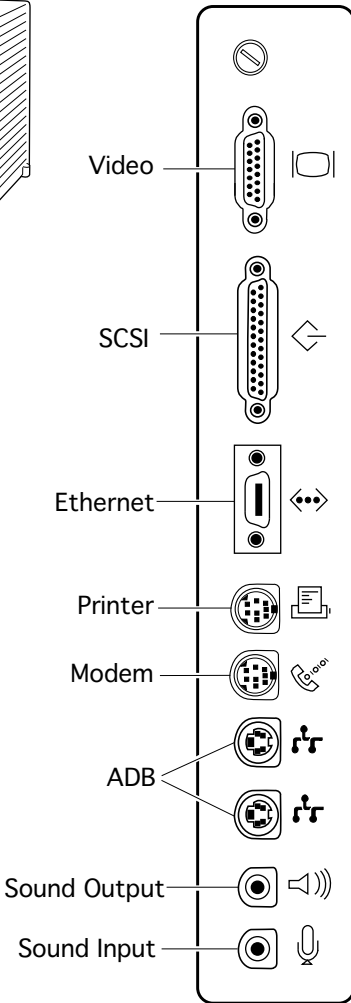
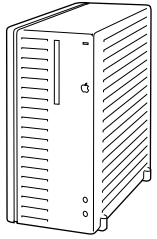

Macintosh Quadra 900/950

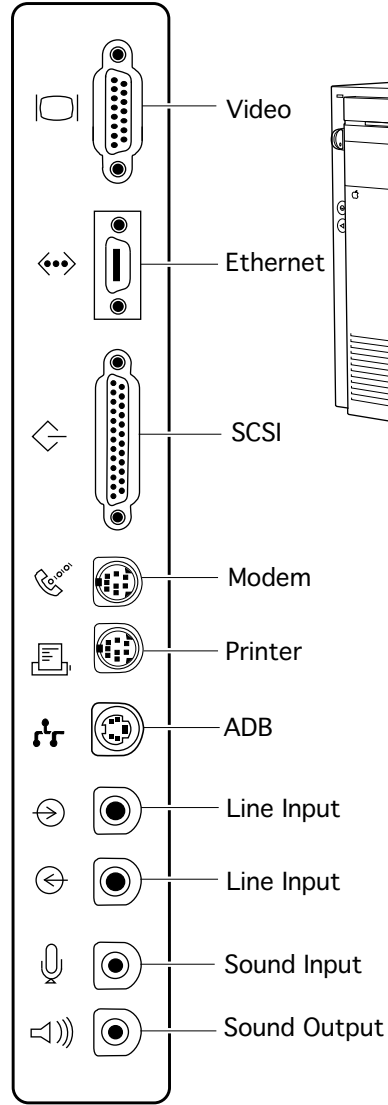
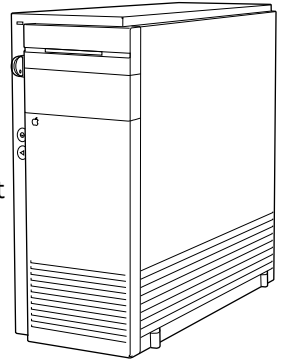

Macintosh LC / LC II / Performa 400

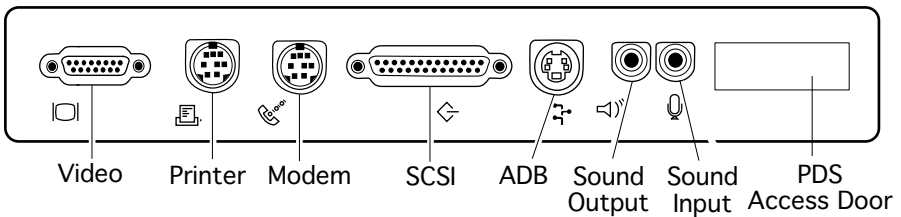
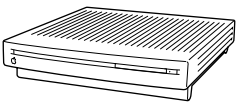



Macintosh Quadra 800

Macintosh Quadra 840AV

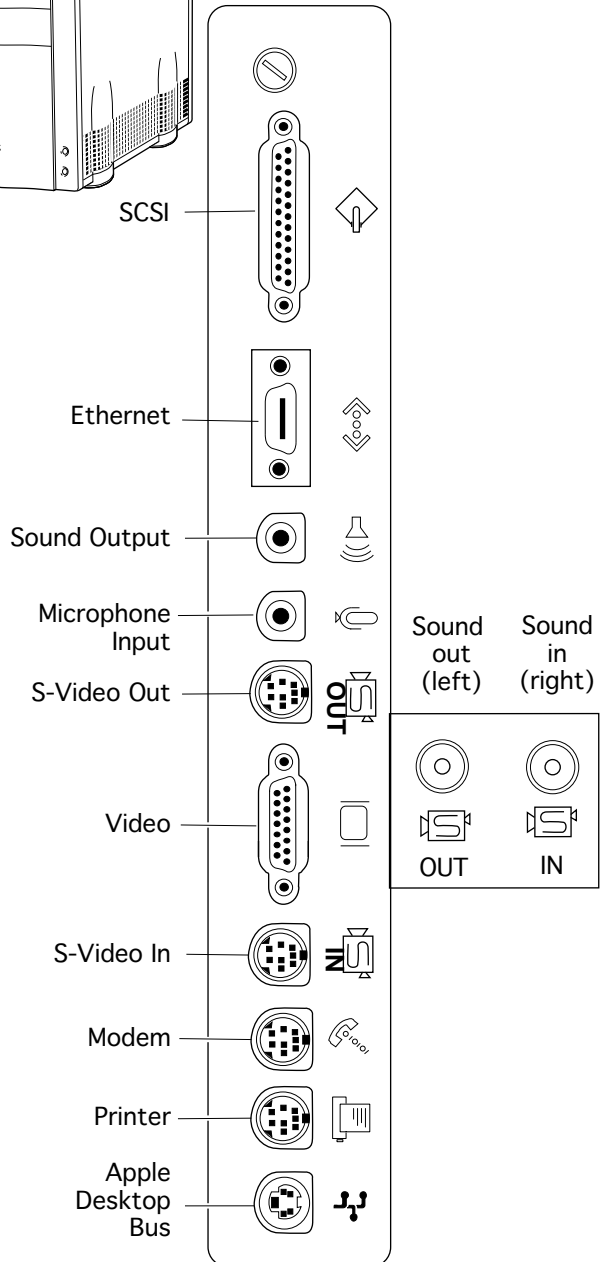
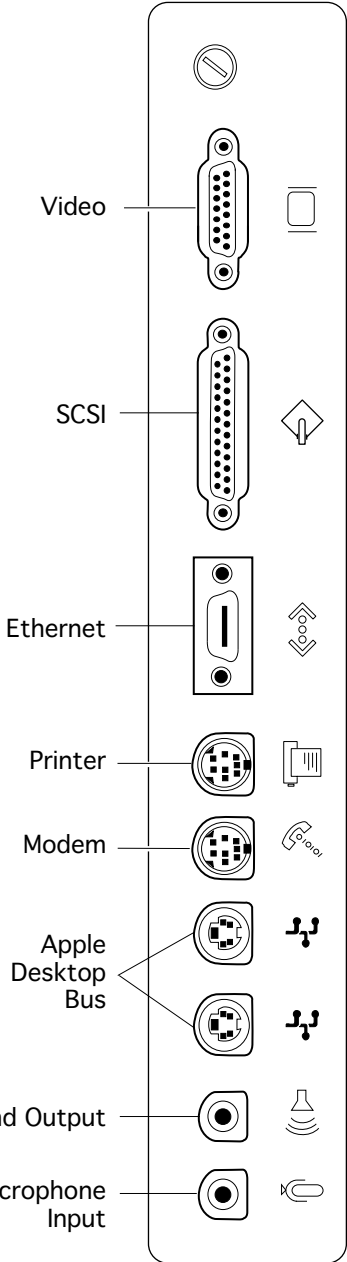
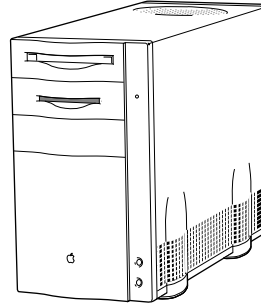

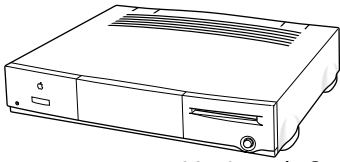

Macintosh Quadra 610; WS 60

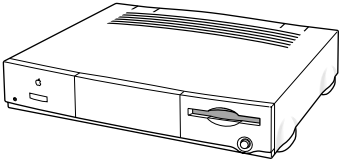
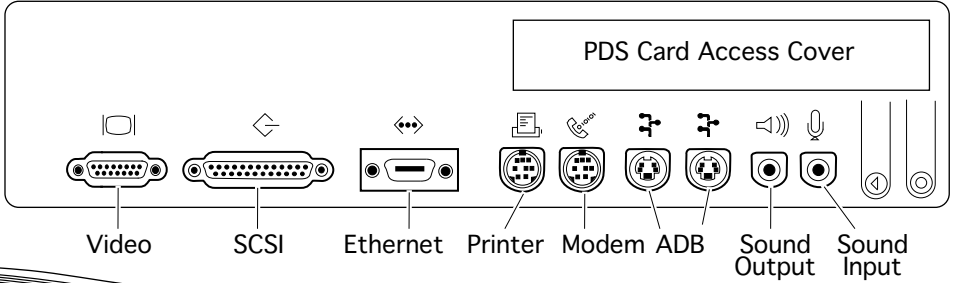

Quadra 660AV

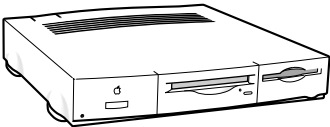
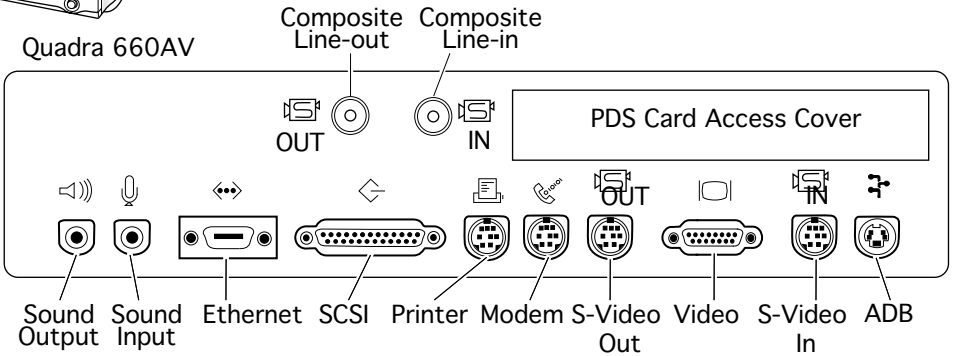

Power Macintosh 6100/60 (no card installed)
Power Macintosh 6100/60AV (AV card installed)

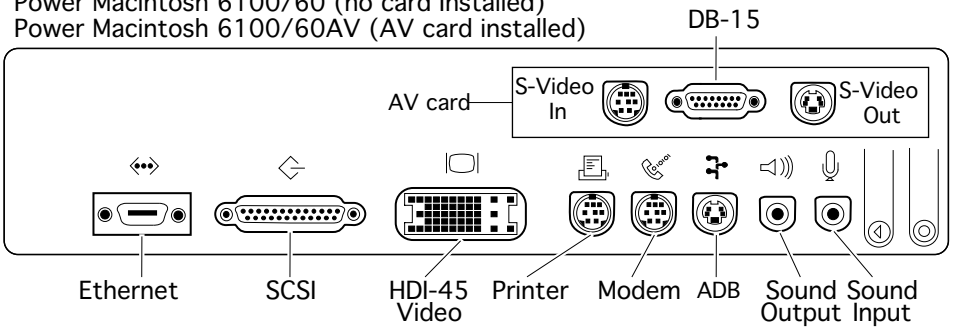



Quadra 650, Performa 600

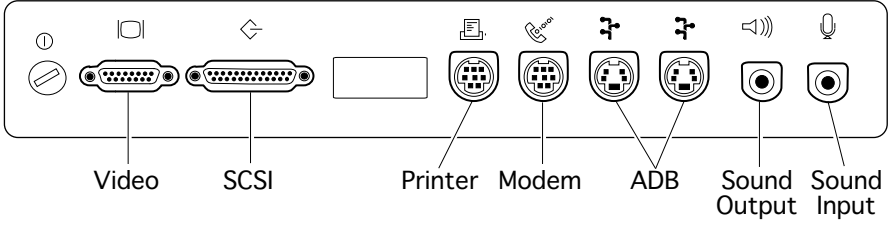

Quadra 650

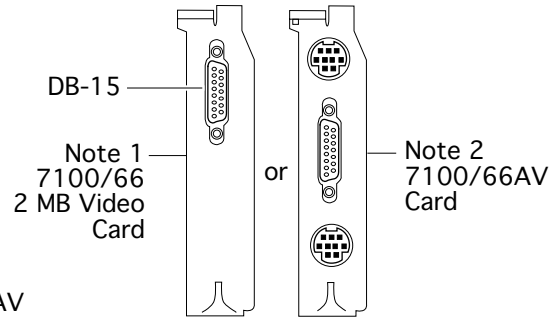
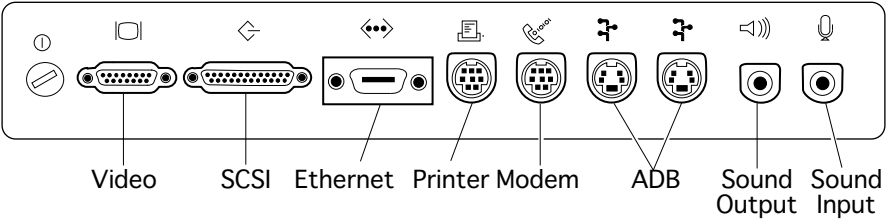

Power Macintosh 7100/66
Power Macintosh 7100/66AV

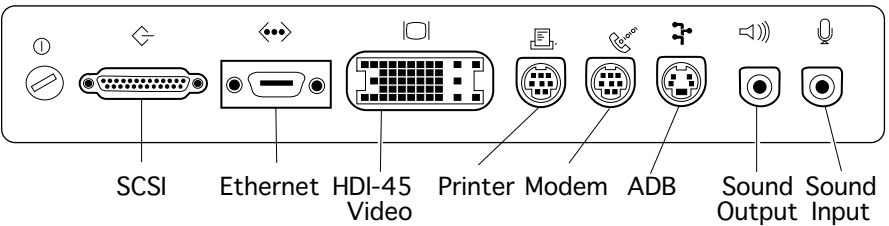

Note 1

The figure shows a Power Macintosh 7100/66 with a 2 MB video card installed (DB-15 connector).

Note 2

The figure shows a Power Macintosh 7100/66AV video card installed (DB-15 connector) and S-Video input and S-Video output ports.





Power Macintosh 8100/80
Power Macintosh 8100/80AV
Workgroup Server 8150

Workgroup Server 95
Workgroup Server 9150

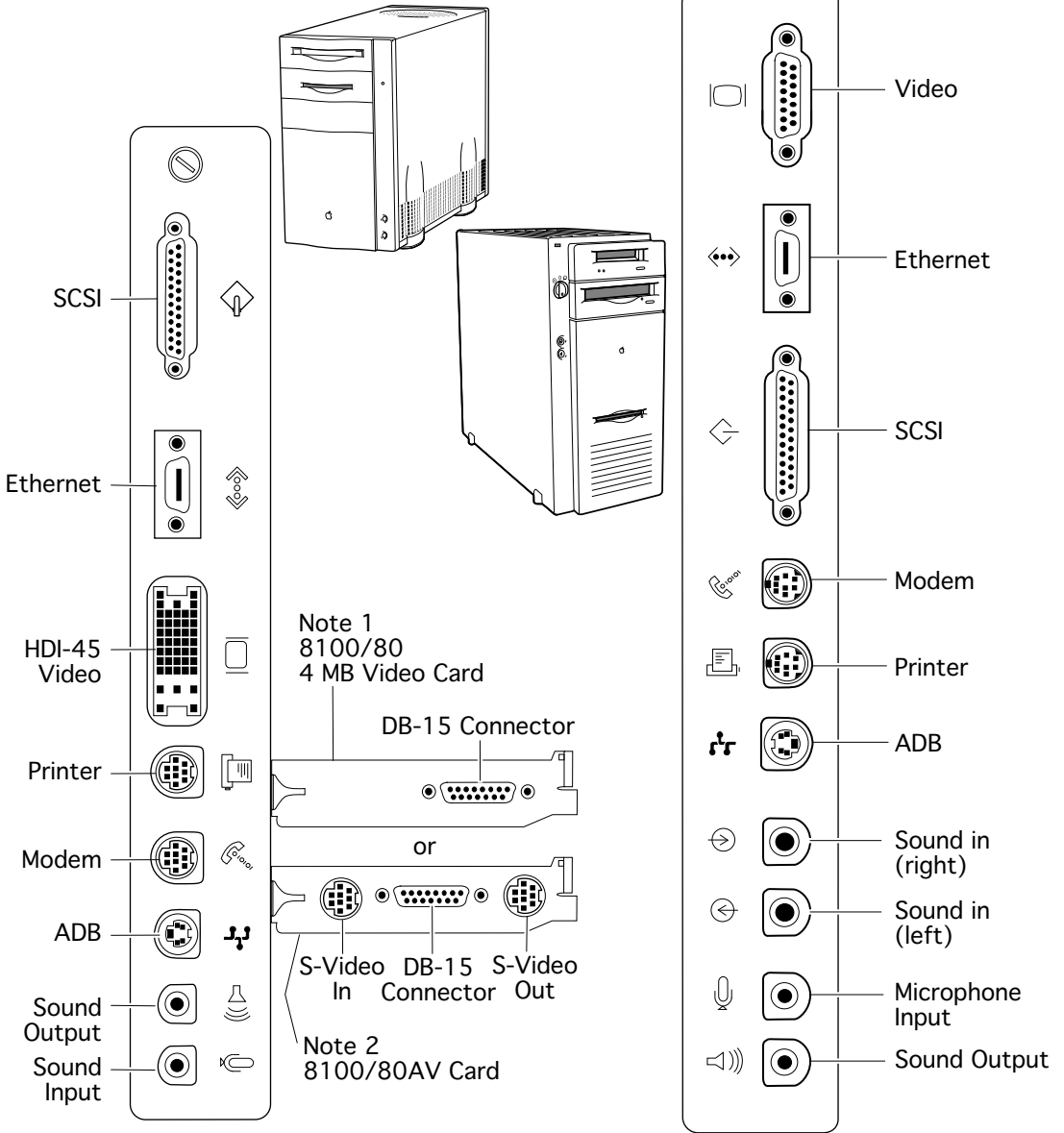

Note 1
The figure shows a Power Macintosh 8100/80 with a 4 MB video card installed (DB-15 connector).

Note 2
The figure shows a Power Macintosh 8100/80AV with a video card installed (DB-15 connector) and S-Video input and S-Video output ports.





LC 580 CD

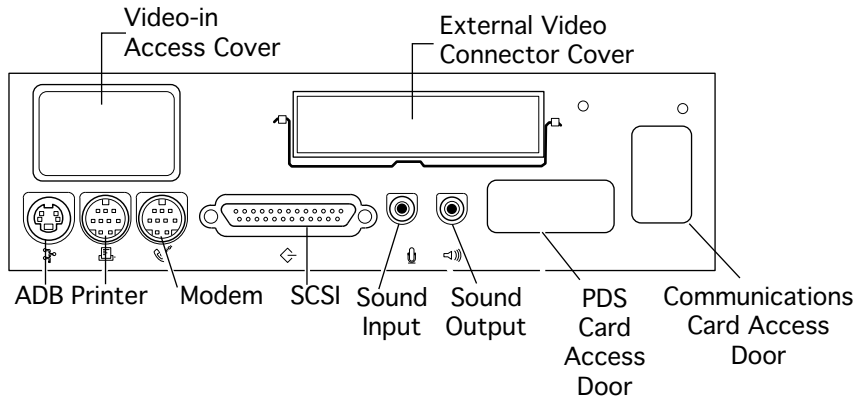
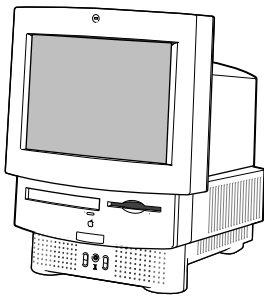

630/640 Series
PM 6200/6300 Series

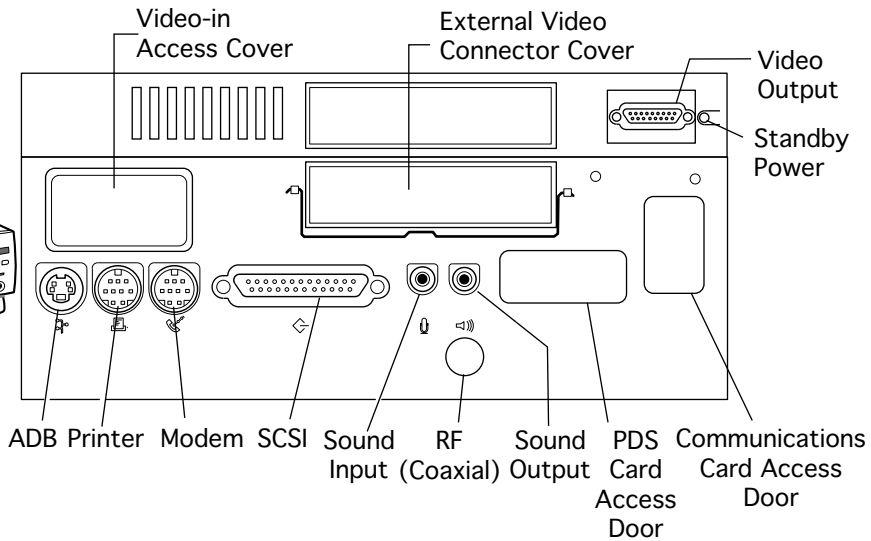
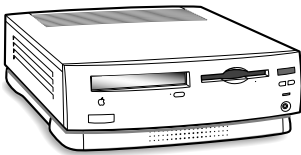



Power Macintosh 4400

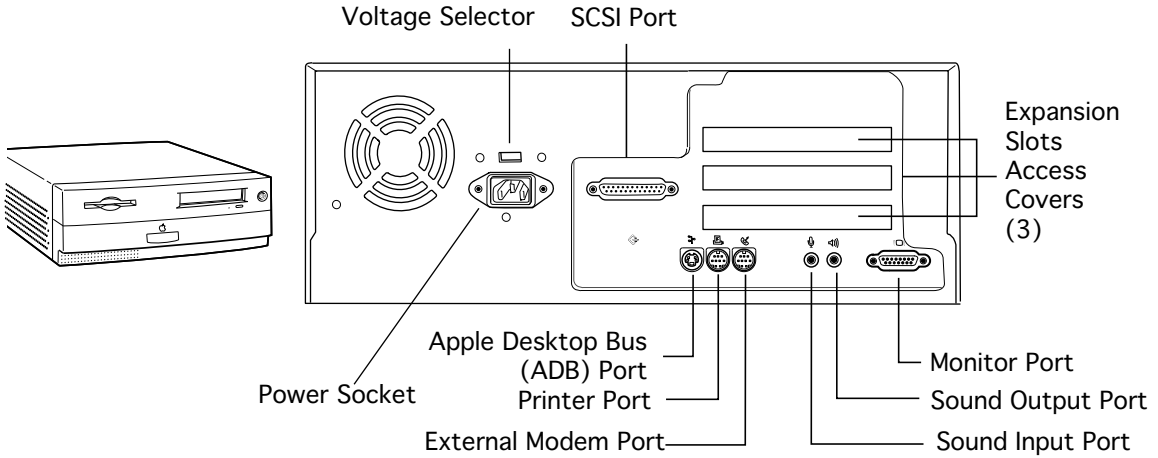

5200/5300 Series

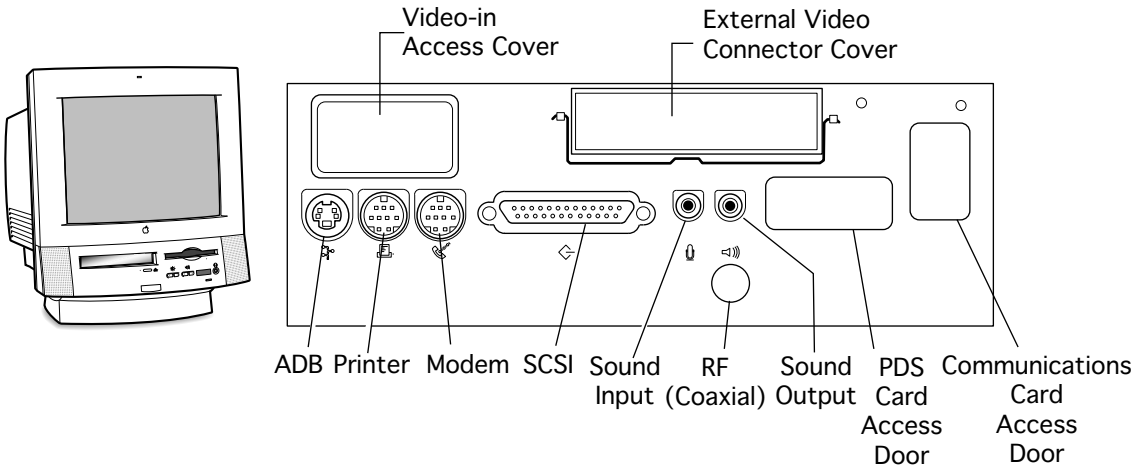



5400/5500 Series

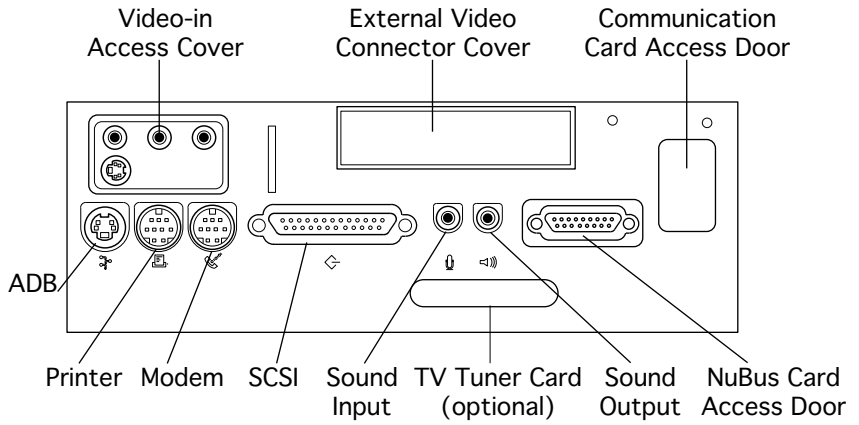
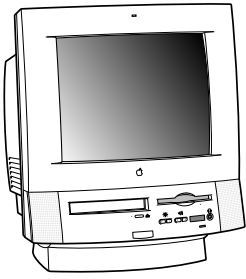

Performa 6360

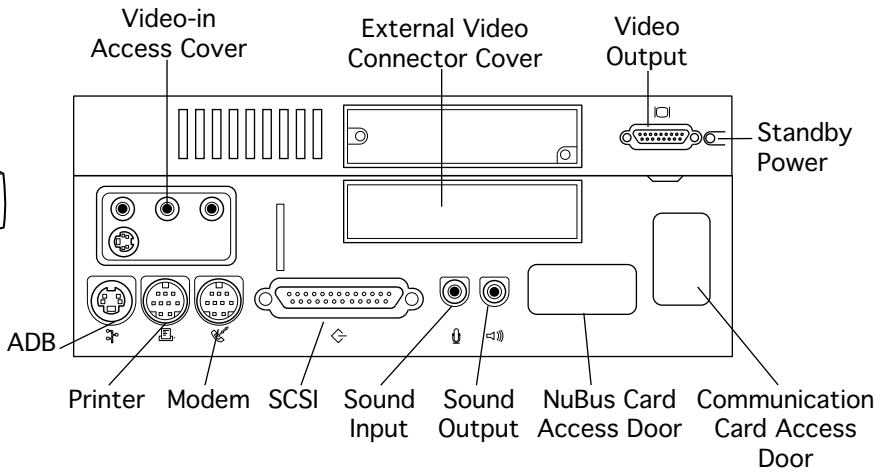
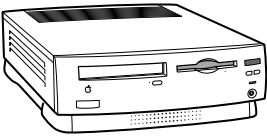

6400/6500 Series

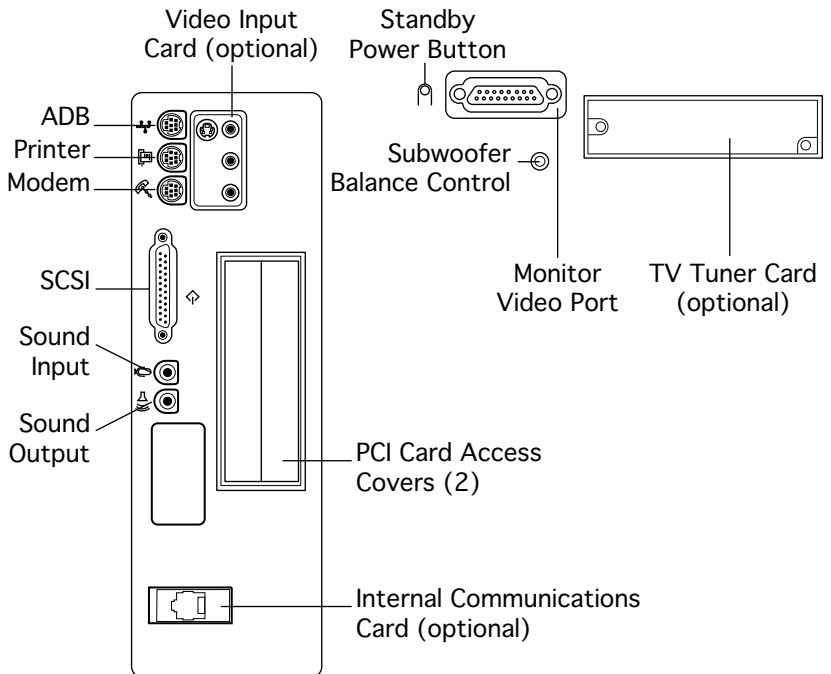
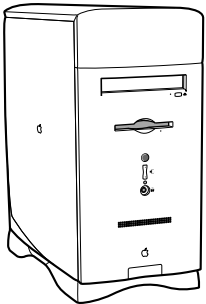



Power Macintosh 7200/7300/WS7350

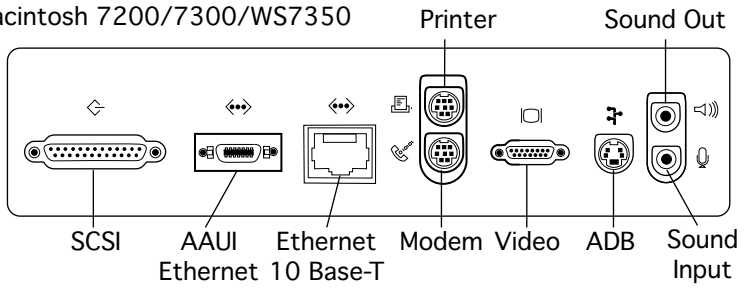
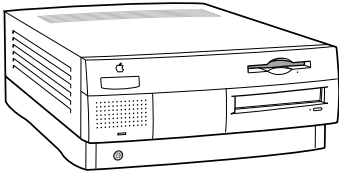

Power Macintosh 7500/7600

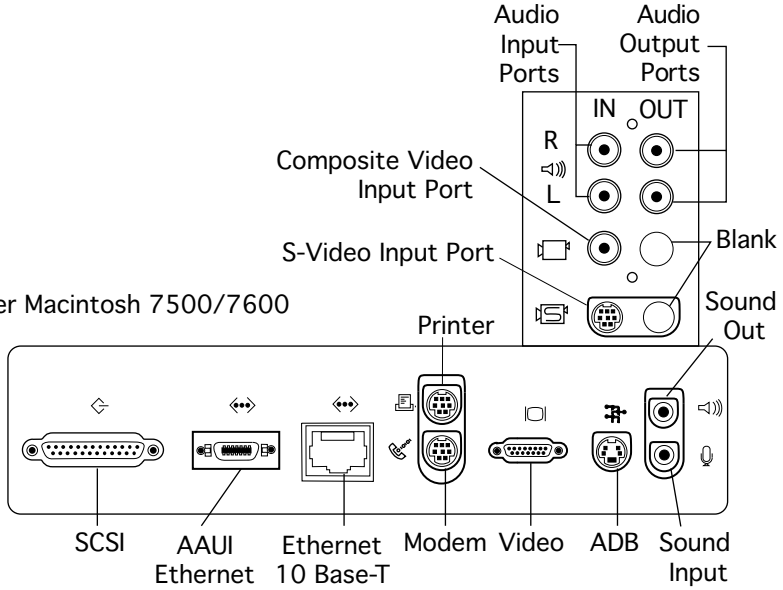
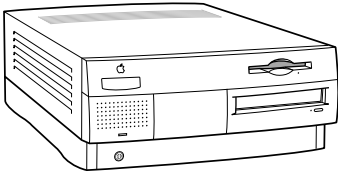

Power Macintosh 8500

Power Macintosh 8200/8550WS

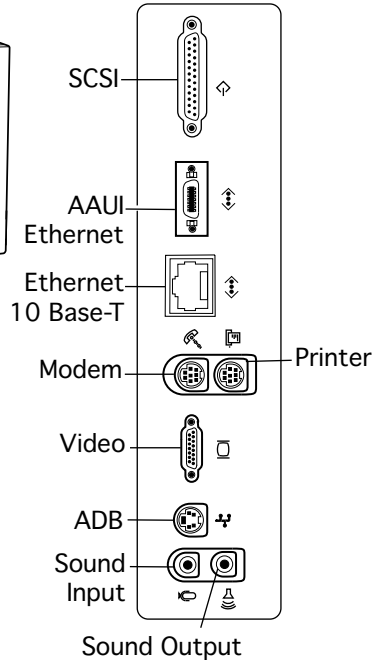
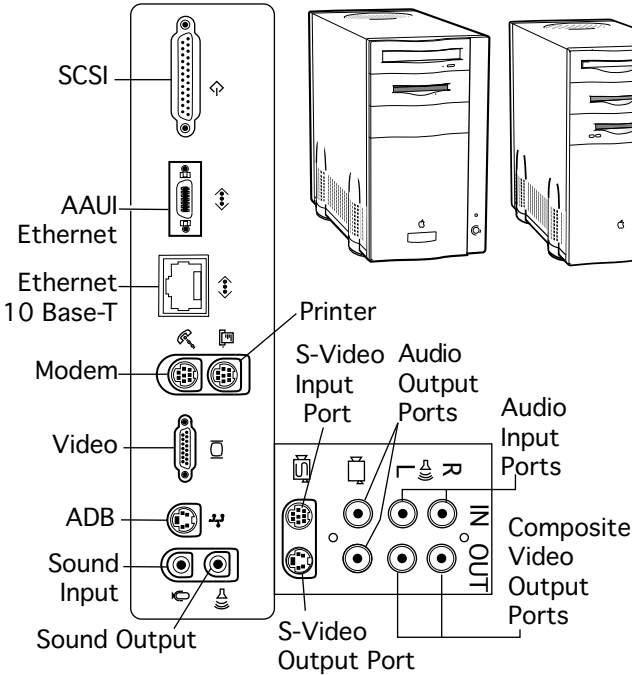
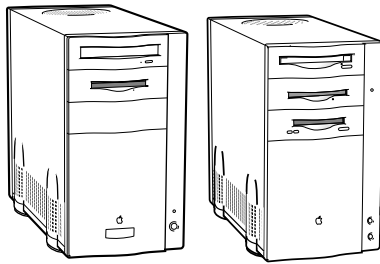



Power Macintosh 8600/200

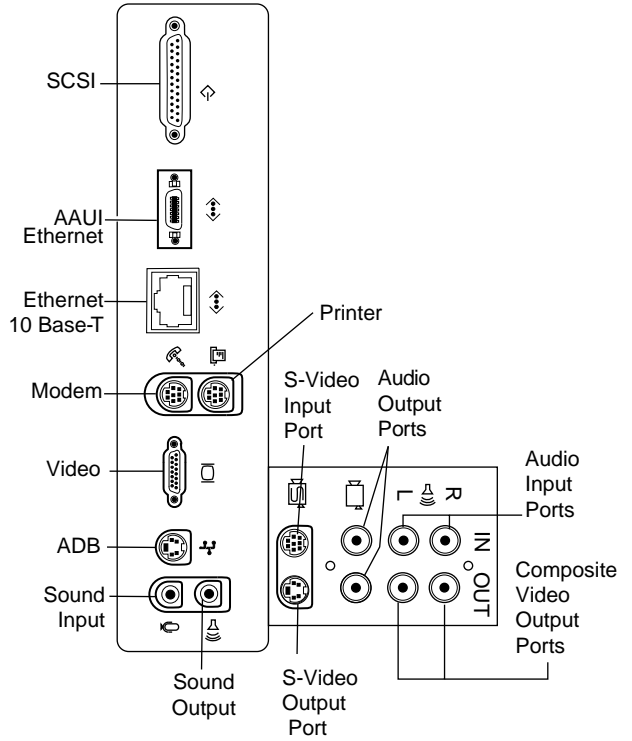
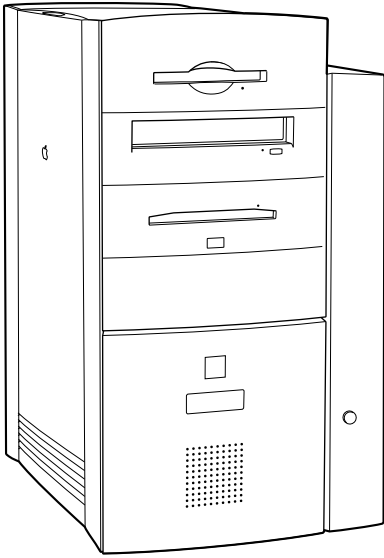

Power Macintosh 9600, WS9650

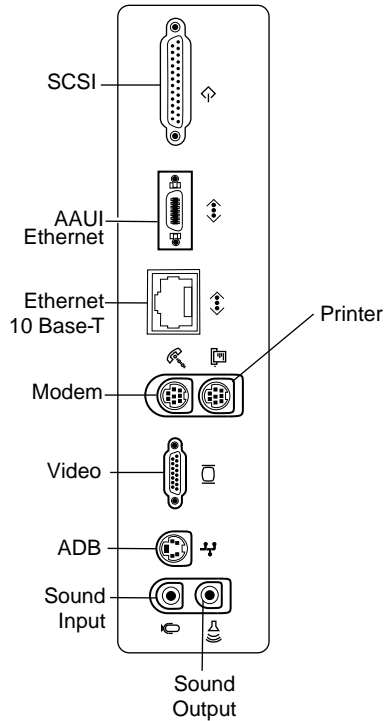
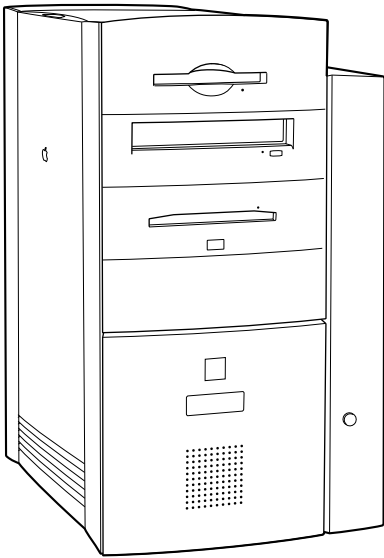



Power Macintosh 9500

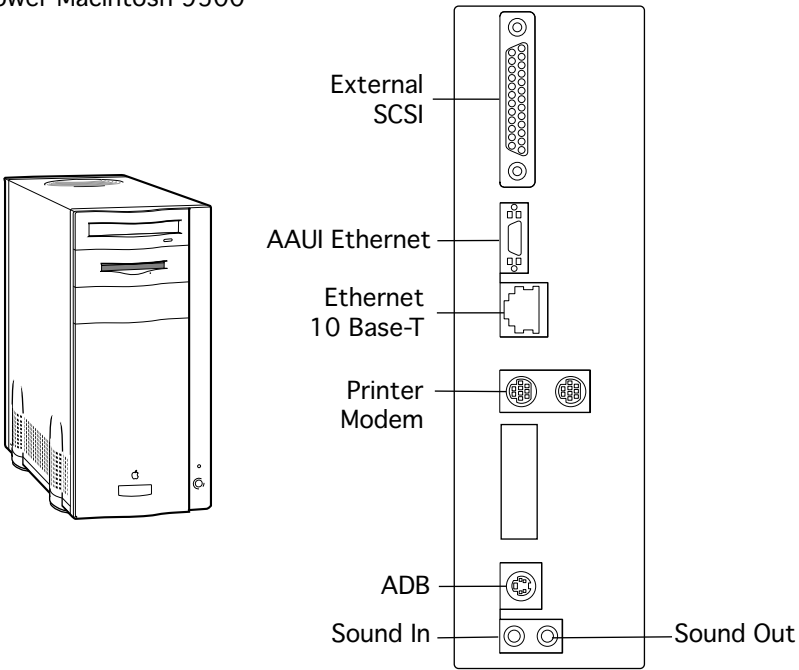

Apple Network Server 500/700

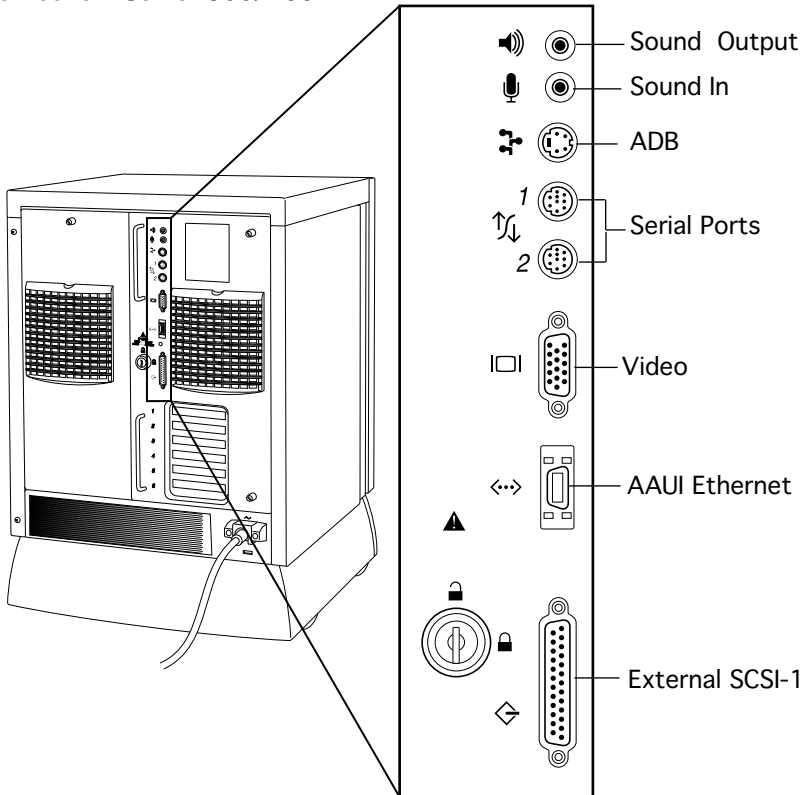

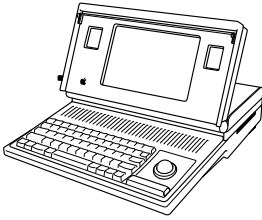

Macintosh Portable

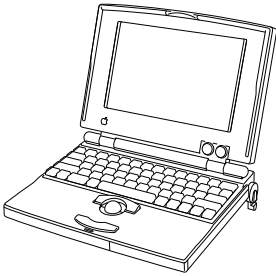
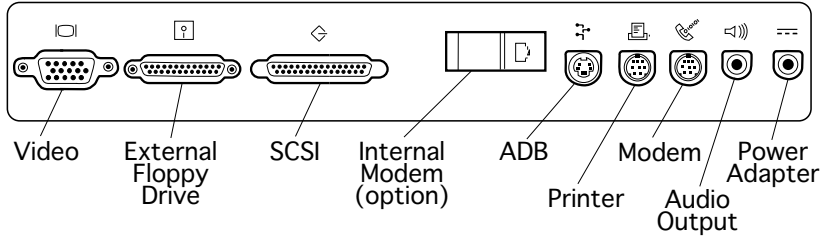

PowerBook 100

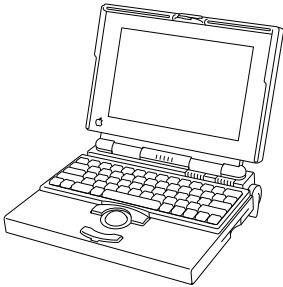
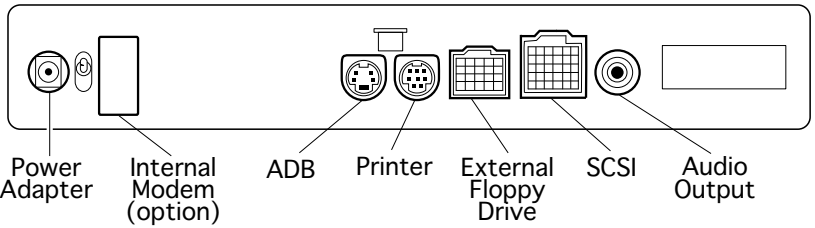

PowerBook 140/145/170

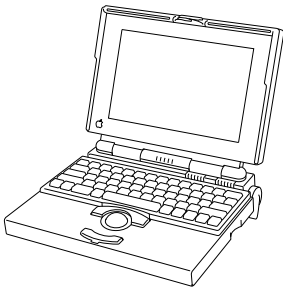
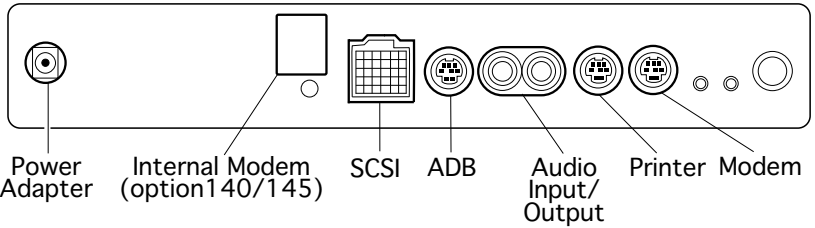

PowerBook 160/180

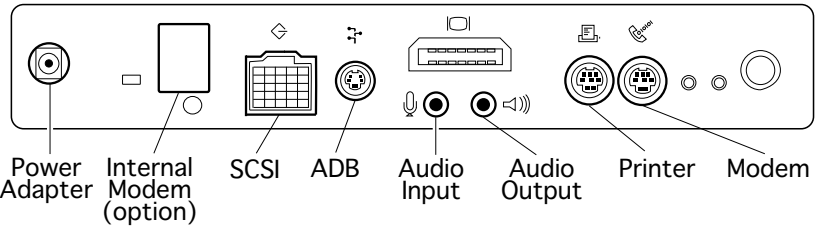



PowerBook 145, 145B, 170

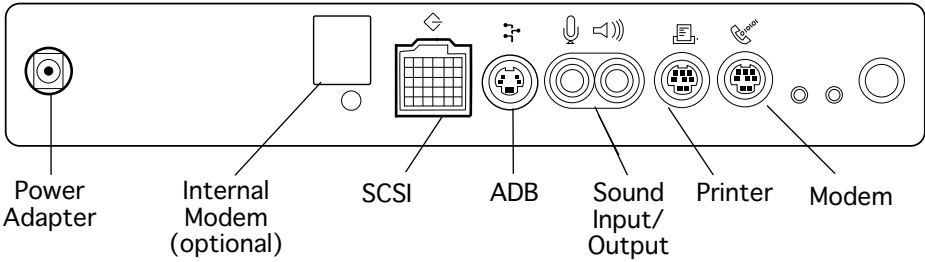
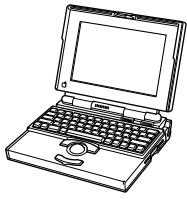

PowerBook 165, 165c, 180, 180c

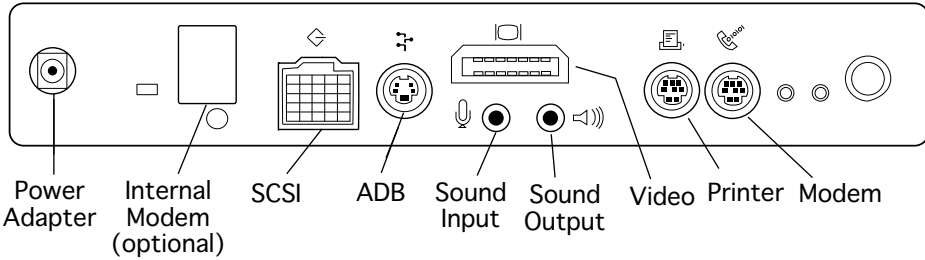

PowerBook 520, 520c, 540, 540c

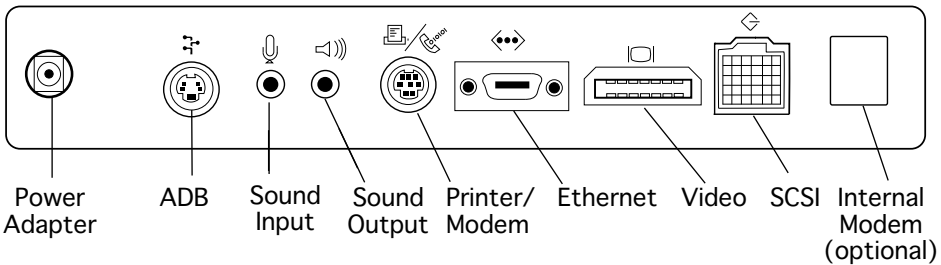

PowerBook Duo 250, 270c, 280, 280c

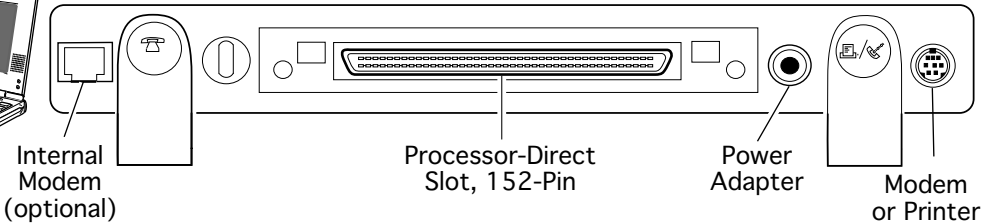
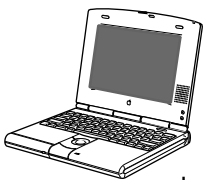

Macintosh Duo Dock II

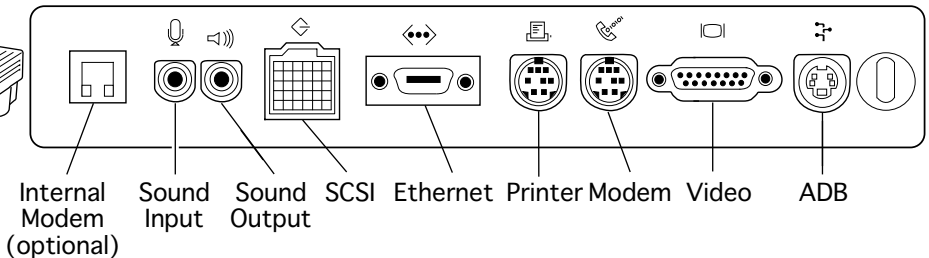
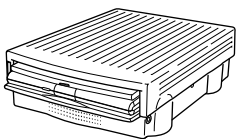

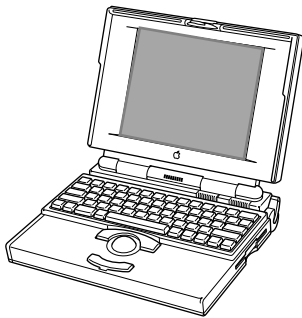

PowerBook 150

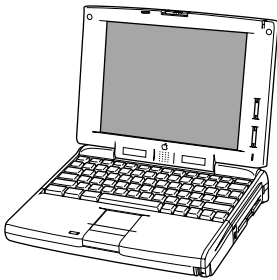
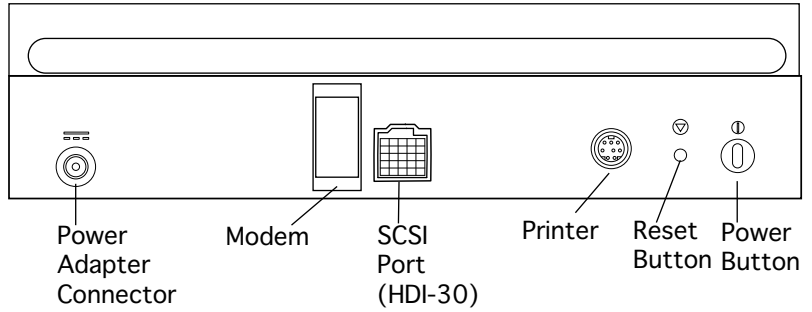

PowerBook 190/5300

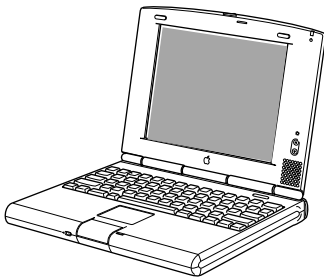
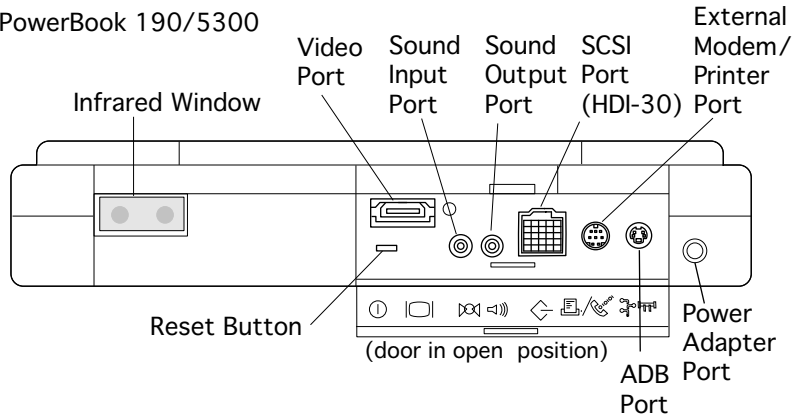

PowerBook Duo 2300 Series

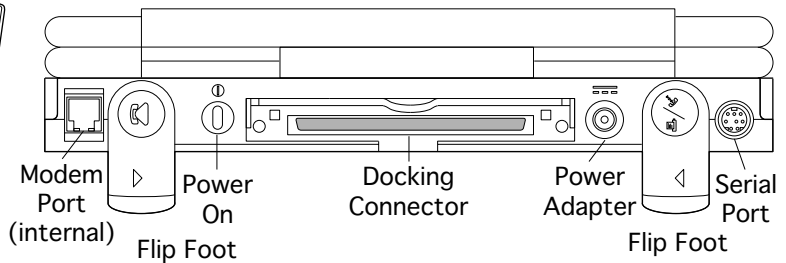



PowerBook 1400

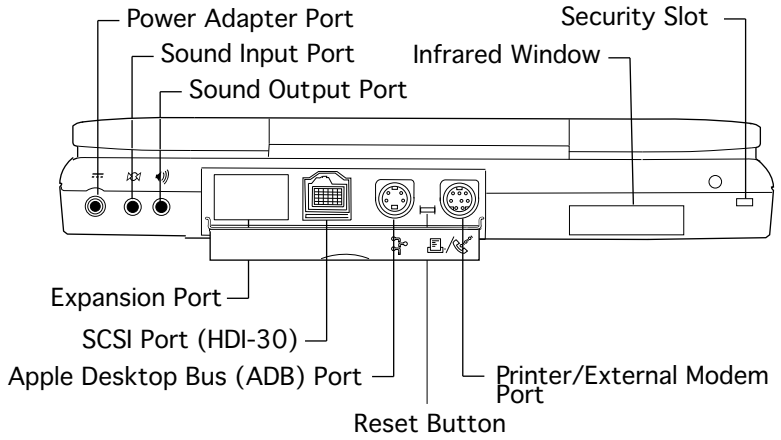
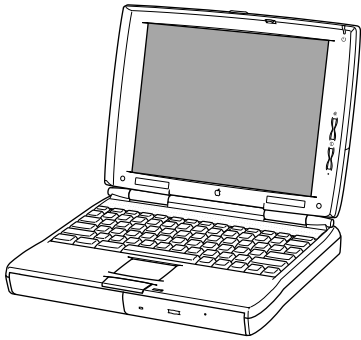

PowerBook 3400

